

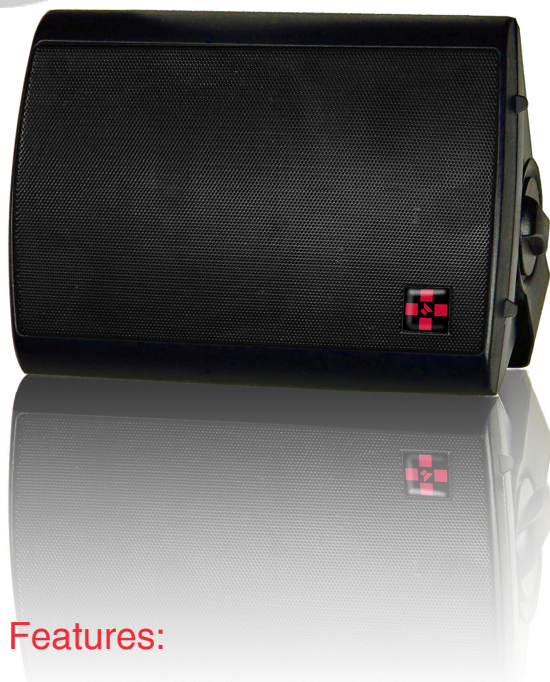

# LS-51T



The LS-51T is a high output acoustic box, which is compound by a 5" woofer and a 1" tweeter.

The enclosure is made of ABS plastic halogens free and low resonance.

The metallic grille included on is transparent acoustically.

The high quality components, which compound this box, allow a high sensitivity.

High pass filter included.

There are some kinds of bracket in order to mounting it. They could be adjustable or fixed.

## Features:

- High output: 89 db (1W, 1m)
- Excellent quality of voice and music transmission.
- Metallic grille transparent acoustically.
- Colours: Black RAL 9005 and white RAL 9003.
- Power taps selector.
- Connector by pressure.

## TECHNICAL SPECIFICATIONS

POWER SUPPLY	30 W RMS
FREQUENCY RESPONSE	200Hz—18 kHz. (+/- 10 dB)
SENSITIVITY	89 dB +/- 3dB (1 W, 1 m)
SPEAKER IMPEDANCE	8 ohm
DISPERSION	90° horizontal / 80° vertical
COLOUR	Black or White
TRANSFORMER 70V / 100V	30W @ 100V ; 15W @ 70V
CONNECTOR	2 x Pressure
SPEAKER	5" Woofer and 1" tweeter
BRACKET (optional)	Adjustable with wall or ceiling fixing.
DIMENSIONS (width x height x depth)	162 x 242 x 182 mm.
WEIGHT	2,5 Kg.

# LS-51T

## Added information:

### Frequency response:

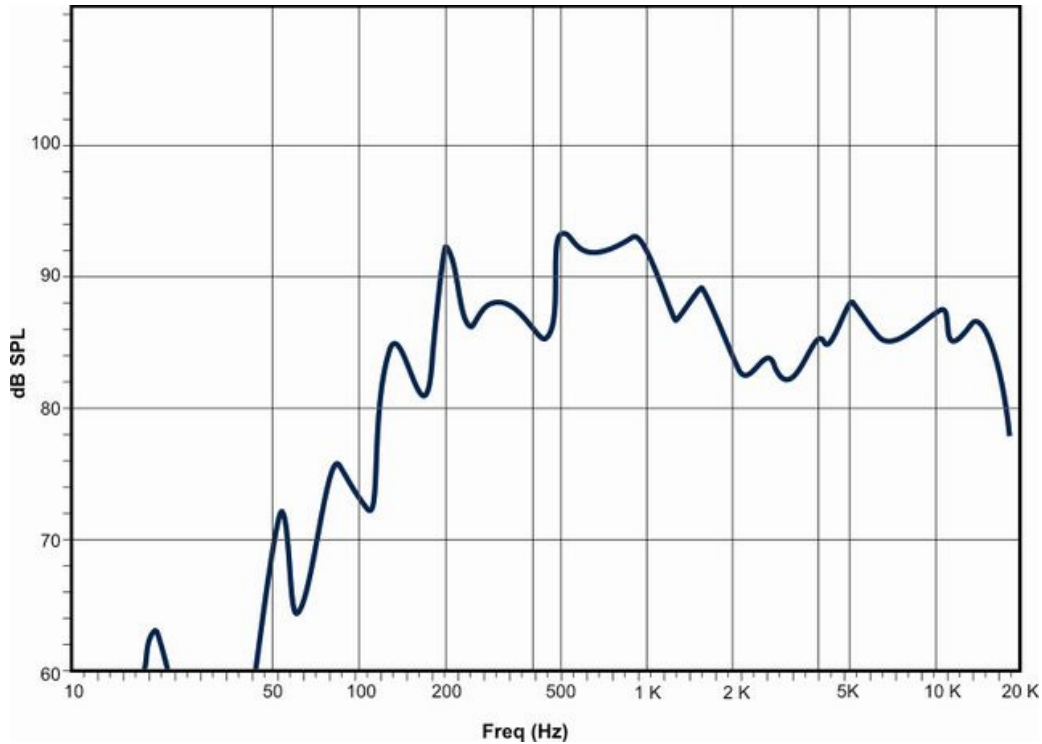

### 8Ω Impedance:

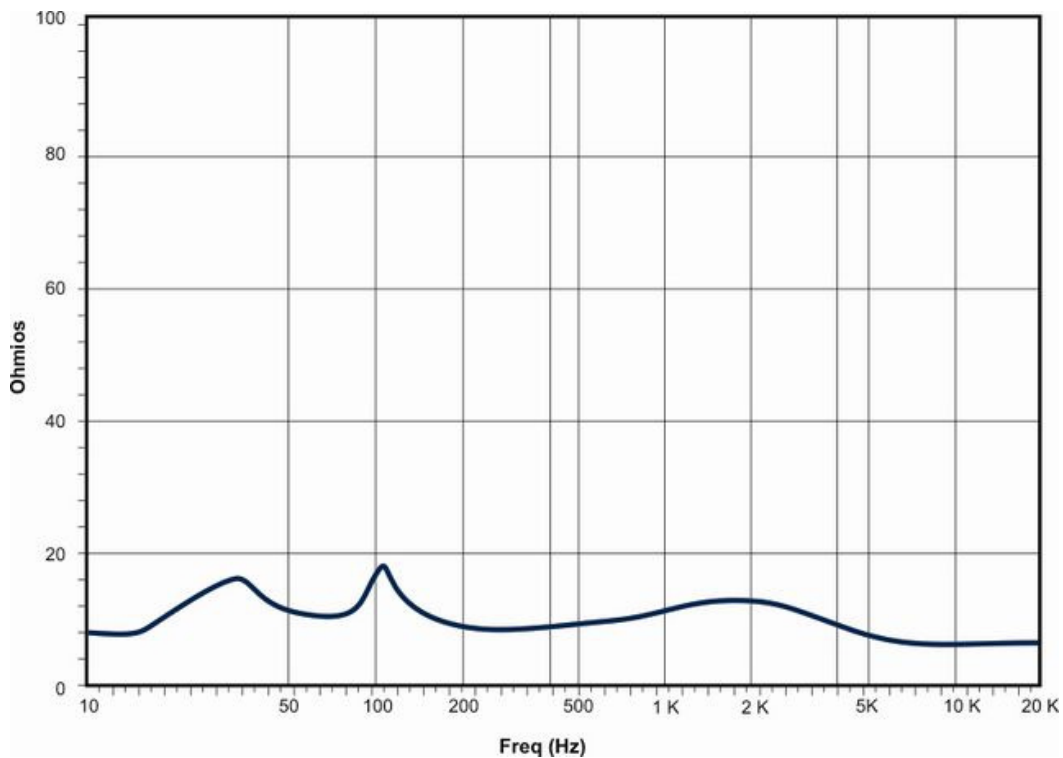

# LS-51T

## Added information:

**Vertical Polar Diagram**  
Frequency: 1 KHz

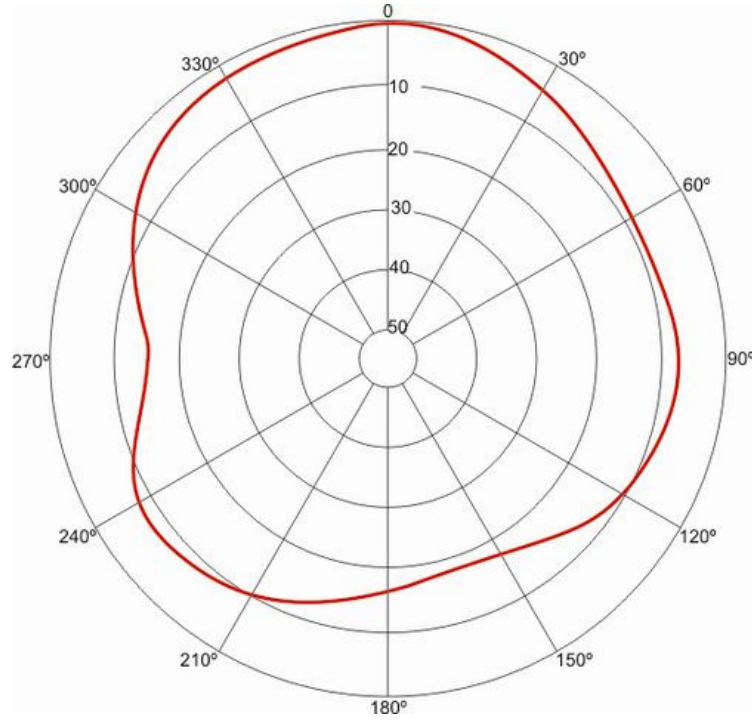

**Horizontal Polar Diagram**  
Frequency: 1 KHz

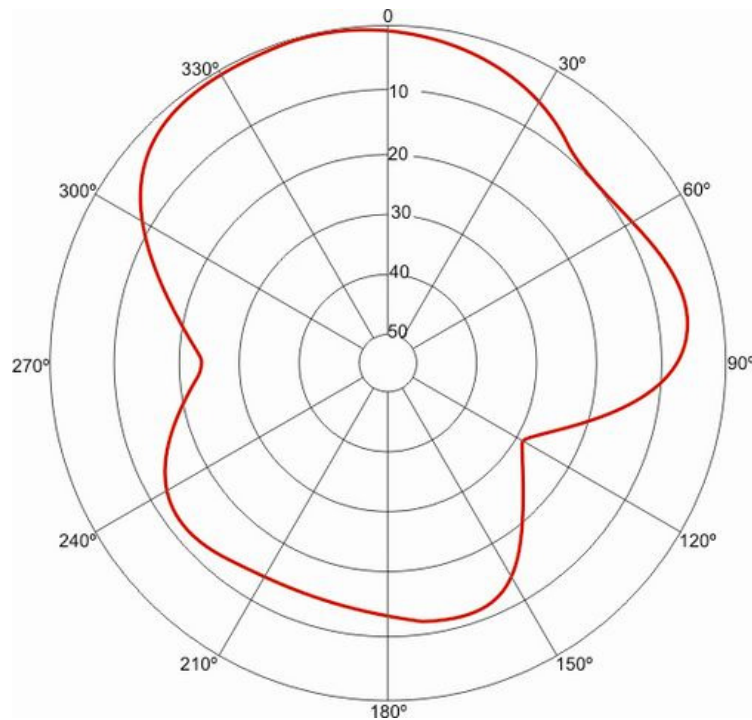

# LS-51T

## Mechanical Drawings:

Dimensions in mm

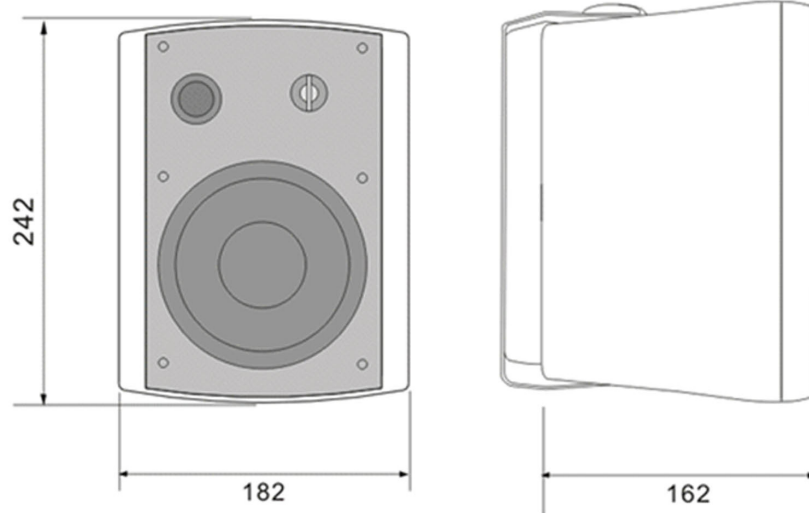

## Bracket in U shape:

Horizontal or vertical installation.

Horizontal position

Vertical position

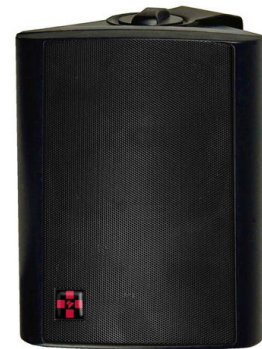
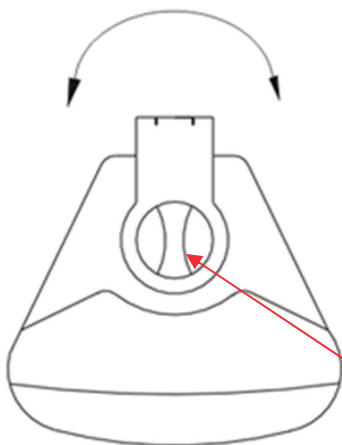

Rotating bracket

# LS-51T

## Power taps selector:

- Power taps selection for 70/100V lines



## Pressure connectors:

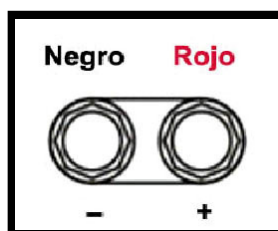

# LS-51T

## SPECIFICATIONS FOR ENGINEERS AND ARCHITECTS

The speaker will be compound by a 5" woofer, a 1" tweeter and a high pass filter. It will be connected to 70 and 100V lines. The range of frequencies that it must cover will be comprised between 200Hz and 18 KHz with a 89dB sensitivity measured to 1W and 1m.

The speaker will be installed horizontally and vertically, where the dispersion will be 90° and 80° respectively.

The enclosure will be made in ABS with a metallic grille transparent acoustically. The available colours will be white (RAL 9003) and black (RAL 9005).

The shape of the box will be a 1/6 spare part of a cylinder. It will be provided by an adjustable bracket, which has U shape and could rotate until 90° angle.

The product fulfills the CE marked.

Warranty 2 years

Product Code LDALS51TS02

# LS-51T

## SPECIFICATIONS FOR ENGINEERS AND ARCHITECTS

### Sound tests:

#### 1. Power

Pink noise is introduced and amplified through the whole band width obeying the standard IEC 60268-5. If the maximum power of the speaker is reached, the noise is cut. Then, the speaker is checked. It must not present visible damages or losses of features after 100 hours of working.

#### 2. Sensitivity, frequency range and impedance.

It is introduced several sinusoidal impulses which have different frequency to 1 W of power level from the nominal impedance of the speaker. The average sound pressure level (dB-SPL) is measured to 1 metre of distance with regard to the speaker in an anechoic environment.

PROFESSIONAL ACOUSTIC BOXES